

## KEY FEATURES

- ✓ No programming skills are needed
- ✓ Functions like center pointing, insertion, hand guiding or path recording
- ✓ Precise presence detection
- ✓ Keep constant force while moving
- ✓ Adds the sense of touch to your robot
- ✓ Dust and water resistant (IP54<sup>1</sup>)



## TECHNICAL SPECIFICATIONS

Sensor Type	6-Axis Force/Torque Sensor			
Dimensions (Height x Diameter)	37.5 x 70 mm			
Weight (with built-in adapter plates)	245g			
	Fxy	Fz	Txy	Tz
Nominal Capacity (N.C)	200 N	200 N	20 Nm	13 Nm
Single axis deformation at N.C (typical)	± 0.6 mm	± 0.25 mm	± 2 °	± 3.5 °
Single axis overload	500 %	400 %	300 %	300 %
Signal noise <sup>2</sup> (typical)	0.1 N	0.2 N	0.006 Nm	0.002 Nm
Noise-free resolution (typical)	0.5 N	1 N	0.036 Nm	0.008 Nm
Full scale nonlinearity	< 2 %	< 2 %	< 2 %	< 2 %
Hysteresis (measured on Fz axis , typical)	< 2 %	< 2 %	< 2 %	< 2 %
Crosstalk (typical)	< 5 %	< 5 %	< 5 %	< 5 %
Working temperature range	0 °C / +55 °C			
Power requirement	DC input range 7-24V		0.8 W	
Mounting screws	5 x M4 X 6 mm 1 x M4 x 12 mm (for the Cable Holder)		ISO14581	

<sup>1</sup> It needs protection when working in corrosive liquid environments

<sup>2</sup> Signal noise is defined as the standard deviation (1  $\sigma$ ) of a typical one second no-load signal.

## MECHANICAL DIMENSIONS

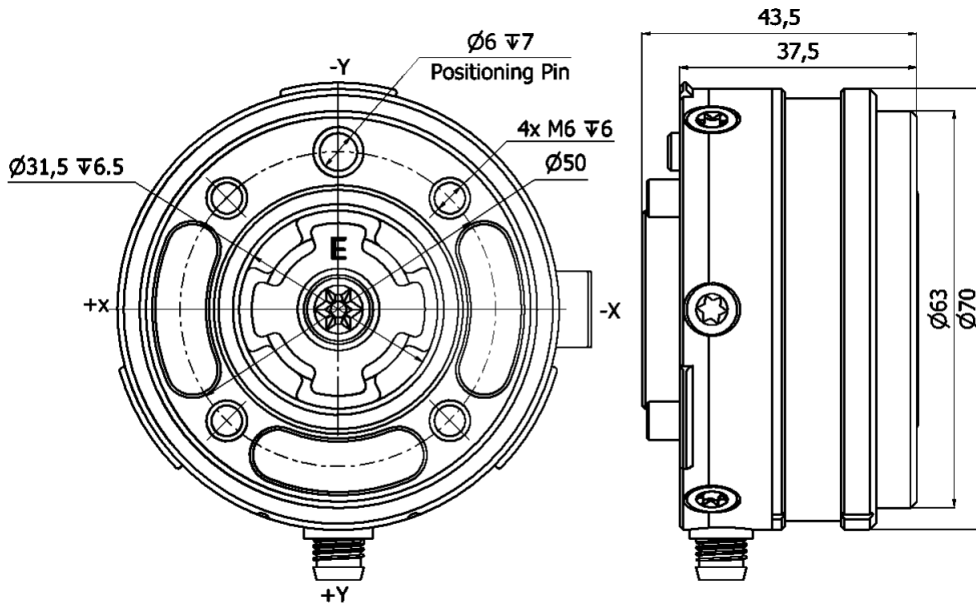

## COMPLEX LOADING

During single-axis loading, the sensor can be operated up to its nominal capacity. Above the nominal capacity the reading is inaccurate and invalid.

During complex loading (*when more than one axis is loaded*) the nominal capacities are reduced. The following diagrams show the complex loading scenarios.

The sensor **cannot be operated** outside of the Normal Operating Area.

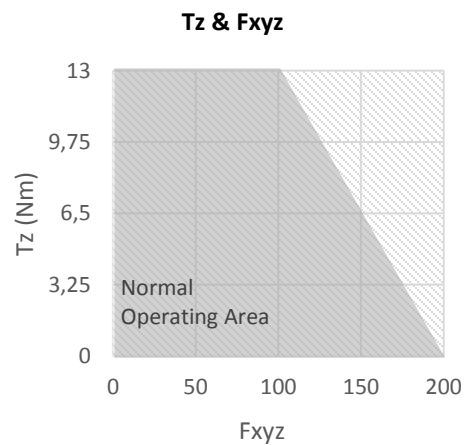
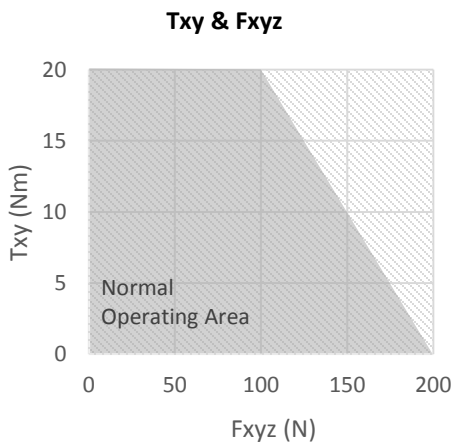

## ADAPTER OPTIONS

Adapter "A2"

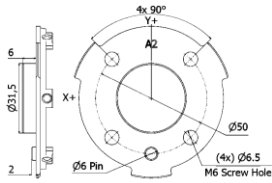

Adapter "B2"

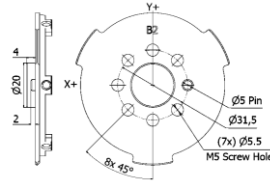

Adapter "C2"

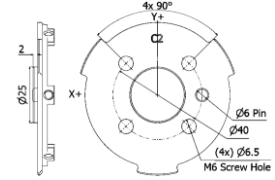

Adapter "A2"	Adapter "B2"	Adapter "C2"
Mounting screws: M6x8 BN20146 (x4)	Mounting screws: M5x8 BN20146 (x7)	Mounting screws: M6x8 BN20146 (x4)
Universal Robots UR3, UR5, UR10	KUKA KR 3 R540	KUKA KR 6
KUKA KR 16, KR 16 S, KR 16 R1610	KUKA KR 6 fivve, KR 6 sixx WP, KR 6 R1820, KR 6 R1820 HP	KUKA KR 16 L6
KUKA KR 20-3, KR 20-3 C, KR 20 R1810	KUKA KR10 fivve, KR 10 sixx WP, KR 10 R1420, KR 10 R1420 HP	ABB 140, 1410 *
KUKA KR 8 R2010	KUKA KR 8 R1620, KR 8 R1620 HP	ABB 1600 *
KUKA KR 12 R1810	ABB 120, 1200 *	
KUKA KR 22 R1610		
KUKA LBR iiwa 7 R800, LBR iiwa 14 R820		

\* Only mechanical compatibility

## INTERFACE TYPES

USB	CAN	Ethernet - TCP/UDP	EtherCAT
Maximum sampling frequency 500 Hz			
Supported systems Windows; Linux; ROS; UR			

## CONNECTOR PINOUT

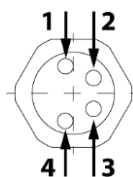

- 1 : V+
- 2 : CAN High
- 3 : V-
- 4 : CAN Low