

KEY FEATURES

- ✓ No programming skills are needed
- ✓ Functions like center pointing, insertion, hand guiding or path recording
- ✓ Precise presence detection
- ✓ Keep constant force while moving
- ✓ Adds the sense of touch to your robot
- ✓ Dust and water resistant (IP54¹)



TECHNICAL SPECIFICATIONS

Sensor Type	6-Axis Force/Torque Sensor			
Dimensions (Height x Diameter)	37.5 x 70 mm			
Weight (with built-in adapter plates)	245 g			
	Fxy	Fz	Txy	Tz
Nominal Capacity (N.C)	200 N	200 N	10 Nm	6.5 Nm
Single axis deformation at N.C (typical)	± 1.7 mm	± 0.3 mm	± 2.5 °	± 5 °
Single axis overload	500 %	500 %	500 %	500 %
Signal noise ² (typical)	0.035 N	0.15 N	0.002 Nm	0.001 Nm
Noise-free resolution (typical)	0.2 N	0.8 N	0.010 Nm	0.002 Nm
Full scale nonlinearity	< 2%	< 2%	< 2%	< 2%
Hysteresis (measured on Fz axis , typical)	< 2 %	< 2 %	< 2 %	< 2 %
Crosstalk (typical)	< 5 %	< 5 %	< 5 %	< 5 %
Working temperature range	0 C° / +55 °C			
Power requirement	DC input range 7-24V	0.8 W		
Mounting screws	5 x M4 x 6 mm 1 x M4 x 12 mm (for the Cable Holder)			ISO14581

¹ It needs protection when working in corrosive liquid environments

² Signal noise is defined as the standard deviation (1 σ) of a typical one second no-load signal.

MECHANICAL DIMENSIONS

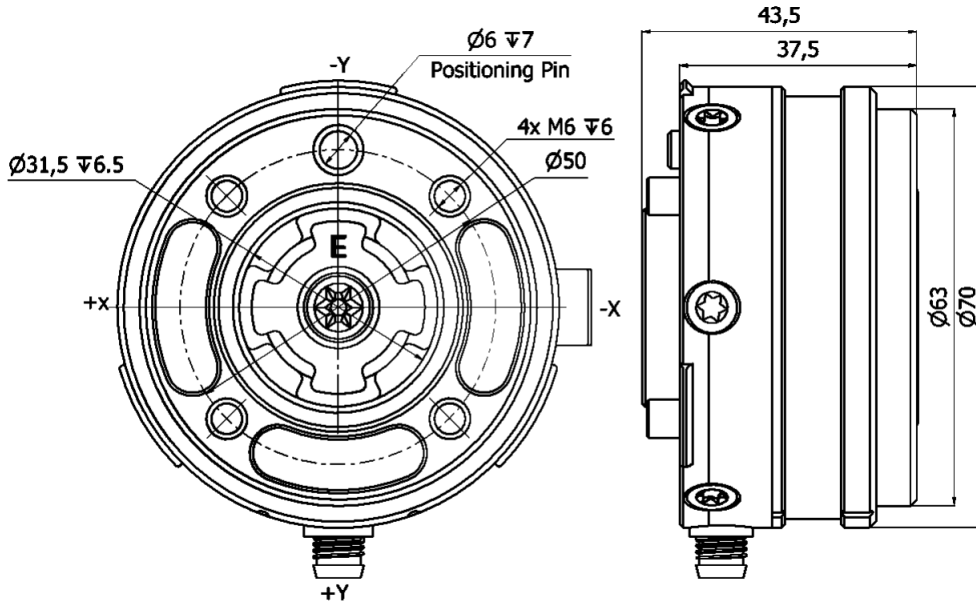

COMPLEX LOADING

During single-axis loading, the sensor can be operated up to its nominal capacity. Above the nominal capacity the reading is inaccurate and invalid.

During complex loading (*when more than one axis is loaded*) the nominal capacities are reduced. The following diagrams show the complex loading scenarios.

The sensor **cannot be operated** outside of the Normal Operating Area.

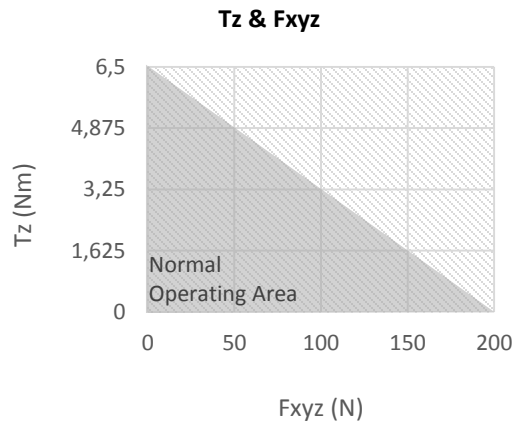
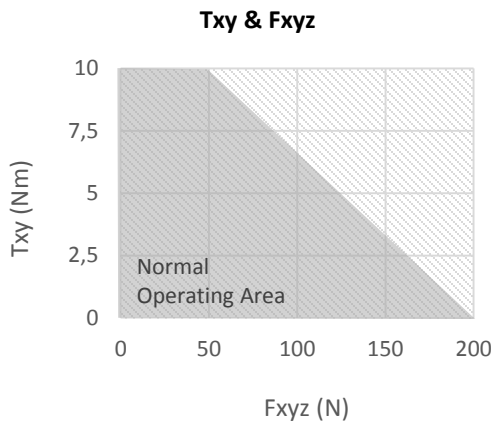

ADAPTER OPTIONS

Adapter "A2"

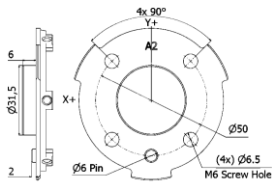

Adapter "B2"

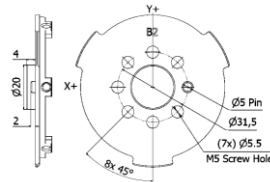

Adapter "C2"

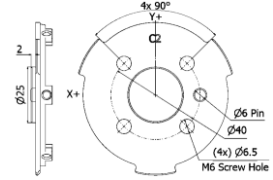

Adapter "A2"	Adapter "B2"	Adapter "C2"
Mounting screws: M6x8 BN20146 (x4)	Mounting screws: M5x8 BN20146 (x7)	Mounting screws: M6x8 BN20146 (x4)
Universal Robots UR3, UR5, UR10	KUKA KR 3 R540	KUKA KR 6
KUKA KR 16, KR 16 S, KR 16 R1610	KUKA KR 6 five, KR 6 sixx WP, KR 6 R1820, KR 6 R1820 HP	KUKA KR 16 L6
KUKA KR 20-3, KR 20-3 C, KR 20 R1810	KUKA KR10 five, KR 10 sixx WP, KR 10 R1420, KR 10 R1420 HP	ABB 140, 1410 *
KUKA KR 8 R2010	KUKA KR 8 R1620, KR 8 R1620 HP	ABB 1600 *
KUKA KR 12 R1810	ABB 120, 1200 *	
KUKA KR 22 R1610		
KUKA LBR iiwa 7 R800, LBR iiwa 14 R820		

* Only mechanical compatibility

INTERFACE TYPES

USB	CAN	Ethernet - TCP/UDP	EtherCAT
Maximum sampling frequency 500 Hz			
Supported systems Windows; Linux; ROS; UR			

CONNECTOR PINOUT

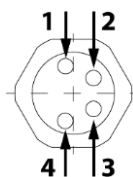

- 1 : V+
- 2 : CAN High
- 3 : V-
- 4 : CAN Low